

CARVER

P R O F E S S I O N A L

MODEL PM-1201 Magnetic-Field Power Amplifier

Owner's Manual

IMPORTANT NOTICE
Please read carefully!

This amplifier was originally manufactured by Carver Corporation. There are references contained within this manual to addresses and telephone numbers that should no longer be used to obtain technical support or factory service.

For any assistance with this product please contact:

Carver Professional
A Division of Phoenix Gold International, Inc.
9300 North Decatur
Portland, Oregon 97203
Tel. 503.978.3344
Fax 503.978.3302

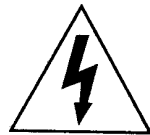
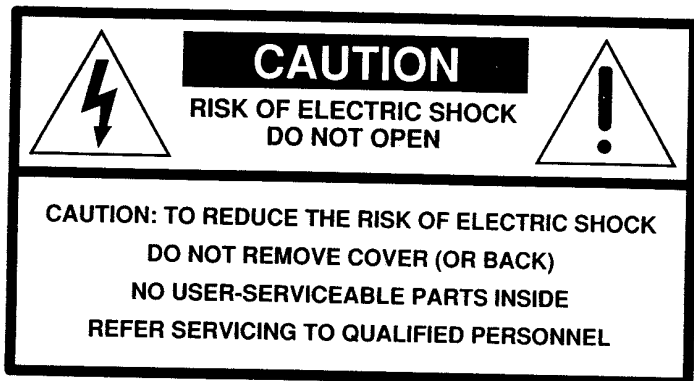

The lightning flash with arrowhead symbol within an equilateral triangle is intended to alert the user to the presence of uninsulated "dangerous voltage" within the product's enclosure, that may be of sufficient magnitude to constitute a risk of electric shock to persons.



The exclamation point within an equilateral triangle is intended to alert the user of the presence of important operating and maintenance (servicing) instructions in the literature accompanying the appliance.

Safety Instructions

1. Read Instructions — All the safety and operation instructions should be read before the Carver Component is operated.
2. Retain Instructions — The safety and operating instructions should be kept for future reference.
3. Heed Warnings — All warnings on the Component and in these operating instructions should be followed.
4. Follow Instructions — All operating and other instructions should be followed.
5. Water and Moisture — The Component should not be used near water - for example, near a bathtub, washbowl, kitchen sink, laundry tub, in a wet basement, or near a swimming pool, etc.
6. Ventilation — The Component should be situated so that its location or position does not interfere with its proper ventilation. For example, the Component should not be situated on a bed, sofa, rug, or similar surface that may block any ventilation openings; or placed in a built-in installation such as a bookcase or cabinet that may impede the flow of air through ventilation openings.
7. Heat — The Component should be situated away from heat sources such as radiators, or other devices which produce heat.
8. Power Sources — The Component should be connected to a power supply only of the type described in these operation instructions or as marked on the Component.
9. Power Cord Protection — Power-supply cords should be routed so that they are not likely to be walked upon or pinched by items placed upon or against them, paying particular attention to cords at plugs, convenience receptacles, and the point where they exit the Component.
10. Cleaning — The Component should be cleaned only as recommended in this manual.
11. Non-use Periods — The power cord of the Component should be unplugged from the outlet when unused for a long period of time.
12. Object and Liquid Entry — Care should be taken so that objects do not fall into and liquids are not spilled into the inside of the Component.
13. Damage Requiring Service — The Component should be serviced only by qualified service personnel when:
 - A. The power-supply cord or the plug has been damaged; or
 - B. Objects have fallen, or liquid has spilled into the Component; or
 - C. The Component has been exposed to rain; or
 - D. The Component does not appear to operate normally or exhibits a marked change in performance; or
 - E. The Component has been dropped, or its cabinet damaged.
14. Servicing — The user should not attempt to service the Component beyond those means described in this operating manual. All other servicing should be referred to qualified service personnel.

PORTABLE CART WARNING



Carts and stands - The Component should be used only with a cart or stand that is recommended by the manufacturer. A Component and cart combination should be moved with care. Quick stops, excessive force, and uneven surfaces may cause the Component and cart combination to overturn.

15. To prevent electric shock, do not use this polarized plug with an extension cord, receptacle or other outlet unless the blades can be fully inserted to prevent blade exposure.

Pour prévenir les chocs électriques ne pas utiliser cette fiche polarisée avec un prolongateur, un prise de courant ou une autre sortie de courant, sauf si les lames peuvent être insérées à fond sans laisser aucune partie à découvert.

16. Grounding or Polarization - Precautions should be taken so that the grounding or polarization means of the Component is not defeated.

17. Internal/External Voltage Selectors — Internal or external line voltage selector switches, if any, should only be reset and re-equipped with a proper plug for alternate voltage by a qualified service technician. See an Authorized Carver Dealer for more information.

18. Attachment Plugs for Alternate Line Voltage (Dual voltage models only)— See your Authorized Carver Dealer for information on the attachment plug for alternate voltage use. This pertains to dual-voltage units only.

WARNING – TO REDUCE THE RISK OF FIRE OR ELECTRIC SHOCK, DO NOT EXPOSE THIS APPLIANCE TO RAIN OR MOISTURE.

1. Table of Contents

1. Introduction	4	Using the PM-1201	11
About This Manual	4	Using the PM-1201 to Drive	
Notational Conventions	4	70V Distribution Systems	11
2. Special Features	5	5. Technical Information	12
Magnetic Field Amplifiers	5	Theory of Operation	12
Stereo Direct 70V Output Capability	5	Low Level Circuitry	12
Clipping Eliminator	5	Power Amplifier Circuitry	12
Protection Circuitry	5	Anti-Clipping Circuit	13
Specifications	6	Magnetic Field Power Supply	13
3. Front and Rear Panel Features	6	DC Fault Protection	14
Front Panel	6	Short Circuit/Low Impedance Load	
Rear Panel	7	Protection	14
4. Installation	8	Display Circuit	14
Mechanical Considerations	8	6. Schematic Diagrams	15
Rear Support for Road Applications	8	PM-1201 Input Board	16
Thermal Considerations	8	PM-1201 Amplifier Board	17
AC Power Considerations	9	PM-1201 Power Supply Board	18
Magnetic Flux Leakage Considerations	9	PM-1201 Regulator/Fan Board	19
I/O Wiring	9	PM-1201 Display Board	20
XLR Connector Polarity (Pin 2 vs. Pin 3)	9	PM-1201 Wiring Diagram	21
Output Connector Wiring	9	7. In Case of Difficulty	22
Ground Lift Strap	9	No Lights, No Sound	22
Bridging Operation	9	Low Output or No Output	22
Clipping Eliminator	10	Distortion	22
Power Sequencer	10	8. Warranty Information	23

A Message from Bob Carver

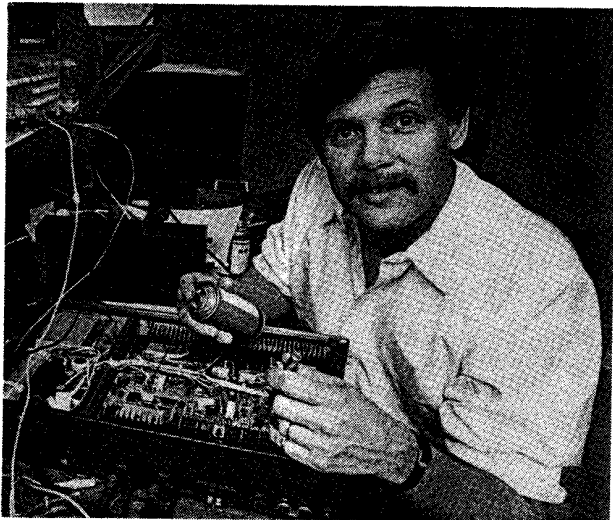

Congratulations on the purchase of your professional PM-1201 Amplifier. It represents the latest technology in Carver's patented Magnetic Field Power Supply. This efficient supply, coupled with a unique amplifier design, provides you with the very best in performance. Because of the specially-designed protection systems, your valuable speakers and amplifier will be protected.

Its lightweight and rugged construction makes it ideal for touring and permanent installations. We are proud of our track record for excellent performance and proven reliability. The high quality standards Carver products provide are the quality that our customers have come to expect.

A handwritten signature in cursive script that reads "Bob Carver".

Bob Carver
Chairman of the Board

1. Introduction

About This Manual

The manual is divided into the following sections:

Introduction. Introduces the PM-1201 and describes the manual and the notational conventions used in the manual.

Special Features. Describes the features that make the PM-1201 unique and lists the specifications.

Front and Rear Panel Features. Describes every knob, button, switch, and connector on the front and rear panels of the PM-1201.

Installation. Covers all aspects of installation: mechanical, electrical, and thermal.

Technical Information. Describes the PM-1201's circuit design.

Schematics. Contains drawings showing the PM-1201 circuit configurations.

In Case of Difficulty. Describes what to do if the PM-1201 won't operate.

Warranty Information. Tells what to do if you need to contact the factory for repair or repair parts.

Notational Conventions

Several notational conventions are used in this manual. Some paragraphs may use **Note**, **Caution**, or **Warning** as a heading. These headings have the following meaning:

Note. Identifies information that needs extra emphasis. A Note may also supply extra information to help you better utilize the amplifier.

Caution. Identifies information that, if not heeded, may cause damage to the amplifier or other equipment.

Warning. Identifies information that, if ignored, may be hazardous to your health or that of others.

2. Special Features

The PM-1201 has several design features that set it apart from the competition:

- Patented Magnetic Field Amplifier circuitry.
- Clipping eliminator.
- Protection circuitry.
- Power Sequencing circuitry.

Magnetic Field Amplifiers

A Carver Magnetic Field Amplifier is the synergism of a highly-efficient, multiple-rail power amplifier and a highly-efficient regulated power supply. Using regulated power supplies for audio amplifiers is nothing new; the difference is in the power transformer and how it is driven.

Conventional amplifiers require the power transformer to be energized 100% of the time that the amplifier is in use. A magnetic field amplifier's power transformer is inside of a voltage regulator's feedback loop; it is only fully operational when needed for full power output. At all other times, the power transformer operates only enough to keep the main filter capacitors charged to plus and minus 124 volts. This allows for a considerable reduction in the size and weight of the power transformer.

The amplifier circuitry uses a triple-rail power supply design. This design minimizes the voltage dropped across each of the output transistors, which minimizes their heat dissipation. By reducing the heat dissipation, the size and bulk of the heat sinks used to transfer this heat to the surrounding air can also be reduced.

This combination of a magnetic field power supply and a high-efficiency output stage yields an amplifier with a high power to weight ratio.

Stereo Direct 70V Output Capability

The PM-1201 has sufficient output voltage capability in stereo mode to drive 70-volt distribution systems without using a step-up transformer at the amplifier. The amplifier delivers 300-watts per channel to the 70-volt system.

Transformers are required at each loudspeaker (as is the case with all 70-volt systems). By re-calculating the tap power ratings on the step-down transformers used at the loudspeaker end, the PM-1201 can deliver additional power beyond 300 watts.

Clipping Eliminator

In addition to sounding bad, clipped waveforms kill loudspeakers. This fact of life is magnified by the practice of using large amplifiers for increased headroom. When an amplifier clips, the output waveform contains large amounts of harmonics which extend both above and below the fundamental frequency. This can be potentially destructive to any high-frequency driver.

The clipping eliminator senses amplifier clipping and reduces the input signal level to limit the distortion in the output signal to less than 1.5% THD with as much as 12 dB of overdrive. The action is similar to that of a limiter. The clipping eliminator is sensitive to clipping, regardless of cause: excessive input drive, power line sag, lower load impedances, etc.

Protection Circuitry

The PM-1201 has specially designed circuitry that protects the amplifier from abnormal external conditions, as well as providing protection to the loudspeakers. The amplifier incorporates the following protective measures:

- Input RFI filtering.
- Power line filtering.
- Load protection from excessive low-frequency or DC output.
- Amplifier protection from sustained current limiting caused by severe overdrive or abnormally low load impedances.
- Thermal overload protection, activated when the transistor mounting surface reaches 100°C.

The two top yellow clipping LED's on the "ladder" display light when the amplifier clips. They will also light continuously while any one of the protection circuits are activated.

PM-1201

Specifications

Power Output (FTC, 20-20kHz, 0.5% THD):

16 ohms, both ch driven	300W
8 ohms, both ch driven	450W
4 ohms, both ch driven	600W
8 ohms mono bridge	1200W
16 ohms mono bridge	1000W

Frequency Bandwidth:

+0 dB, -3dB, 3Hz-80kHz

IM Distortion (SMPTE):

Less than 0.1%

Gain:

33 dB

Input Sensitivity (full output):

1.2V RMS (+4dBu)

Input Impedance:

- 30 Kilohms balanced
- 30 Kilohms unbalanced (non-inverting +)
- 15 Kilohm unbalanced (inverting -)

Input Overload:

+19 dBu

Slew Rate:

25 V/ μ Sec

Damping Factor:

200 @ 1kHz

Output Noise (A weighted):

-105 dB, ref 450W output, A-weighted

Inputs (balanced, differential):

XLR, 1/4 inch TRS (tip-ring-sleeve)

Power-up Sequencing:

Barrier Strip

Receive accepts +5 to +15V to activate power on;

Send provides delayed +15V output to activate next unit

Output:

5-way binding posts

Dimensions (HxWxD):

3.5" x 19.0" x 12.0" (13.25" including handles)
89mm x 482mm x 305mm (336mm including handles)

2U rack space

Net Weight:

24.3 lbs. (11.0 kg)

Shipping Weight:

28.1 lbs. (12.7 kg)

Power Requirements:

120V, 60Hz, 12A, 1400 Watts

Other voltages available for export.

Note: Carver Corporation reserves the right to improve its products at any time. Therefore, specifications are subject to change without notice.

3. Front and Rear Panel Features

Front Panel

The following paragraphs describe the controls, switches, jacks and displays found on the front panel of the PM-1201. Refer to Figure 1.

1. MAIN POWER Switch. Manual power switch. Use this switch when you are not using the remote power-up sequencer feature. If the SEQUENCER switch is on, the manual power switch will still operate as long as there is no control voltage present at the sequencer RECEIVE terminal.

2. SEQUENCER Switch. This switch enables remote power-up sequencing. The amplifier's MAIN POWER switch should be set to the OFF position when using this feature.

3. LEFT and RIGHT Level Controls. 11-step attenuators that adjust the relative output level of the PM-1201. The amount of attenuation corresponds to the front-panel marking, in dB.

4. Output Status Display. 7 LED's (per channel) indicating the status of the amplifier. The bottom green LEDs indicate power-on. The five red LEDs indicate the output power level of

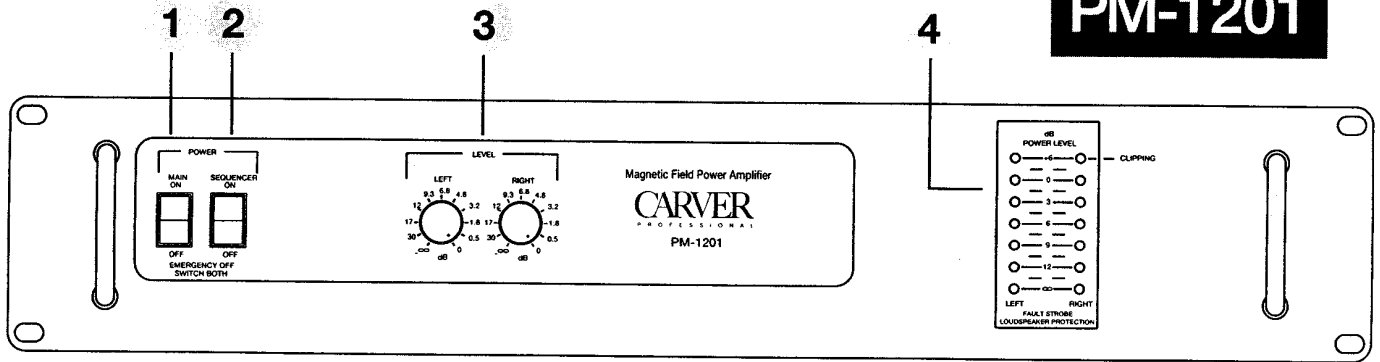

Figure 1.

the amplifier in dB relative to maximum output. The top yellow LEDs indicate the onset of clipping.

If the bottom (green) LEDs turn off and the top (yellow) LEDs illuminate dimly, it indicates that the internal fault-protection circuits have been activated. Check all wiring, especially the speaker wiring.

Rear Panel

The following paragraphs describe the various rear panel features of the PM-1201. Refer to Figure 2.

1. MONO. Pressing this switch sets the PM-1201 for bridged mono operation. Use this mode for 8 ohm or greater loads.

2. INPUTS. Each channel has parallel connected female XLR connectors and 1/4 inch tipping-sleeve (TRS) phone jacks. These are the input connectors for the amplifier. Since the jacks are connected in parallel, the remaining jack can be used as an output when daisy-chaining several amplifier inputs.

3. LEFT/RIGHT SPEAKER OUTPUT. 5-way binding posts used to connect the loudspeakers to the amplifier outputs. The red terminal is the signal connection, the black terminal is the signal return connection. The black terminals are internally connected together.

4. CLIPPING ELIMINATOR. Pressing this switch activates the clipping eliminator circuit. In this mode, the amplifier output remains undistorted even when overdriven by up to 12dB.

5. SIGNAL/CHASSIS Ground Terminal. Removing this jumper isolates the amplifier's power supply ground from the amplifier chassis. This may be necessary to eliminate ground loops in some systems. The amplifier chassis is always connected to the safety ground (line plug ground or green wire) of the power cord. With the jumper removed, the amplifier's circuit ground is connected to the amplifier's chassis ground via a 27-kilohm resistor in parallel with a 0.1µF capacitor.

CANADIAN MODEL ONLY: The potential difference between these two terminals is always limited to less than 4 volts, regardless of how external circuits are connected.

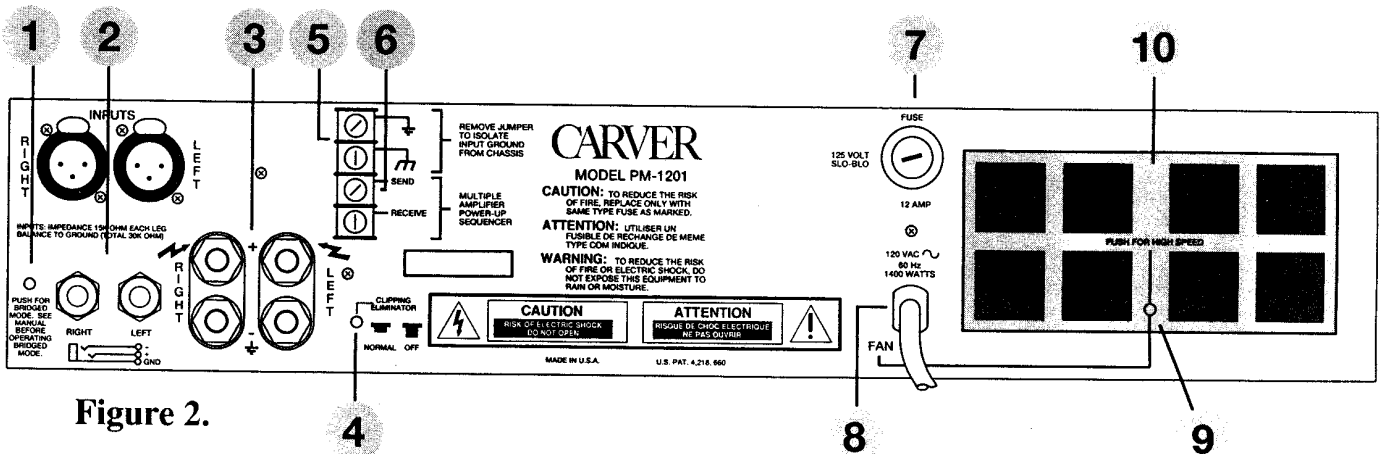

Figure 2.

6. SEND/RECEIVE Terminals. Barrier strip terminals used to link multiple amplifiers for sequenced turn-on. Connect the SEND connection of the first amplifier to the RECEIVE connection of the second PM-1201. Connect the SEND connection of the second amplifier to the RECEIVE connection of the third PM-1201, and so on.

7. FUSE. AC power line fuse for the PM-1201.

Use only one of the following fuses for 120-volt models of the PM-1201:

Bussman MDA 12-amp
Littlefuse 3AB 12-amp

For 230-volt models of the PM-1201 use:

Bussman GDC 6.3-amp
Littlefuse 218 6.3-amp
Schurter FST (034.3125) 6.3-amp

Repeated fuse blowing is a sign of internal distress. Have an authorized Carver service technician examine the amplifier.

8. POWER CORD. Connect to a properly configured outlet providing the line voltage specified for your model.

9. HIGH SPEED Switch. Push switch that controls the idle speed of the fan. Use the low speed position in applications that require low acoustic noise output.

10. FAN FILTER. Expanded foam filter that keeps dust and airborne debris out of the amplifier's cooling system. The filter should be washed whenever it shows signs of dust buildup. It is not a good idea to operate the amplifier without the filter in place. Replacement filters can be ordered from Carver (Part Number 105-10005-00).

4. Installation

The PM-1201 may be used free-standing or installed inside a rack enclosure. Installation consists of the actual mechanical installation, and the electrical and thermal considerations required. The remaining paragraphs in this section describe the procedure.

Mechanical Considerations

The PM-1201 requires two rack spaces (3.5 inches total). The amplifier requires 12.0 inches depth inside the rack. Secure the unit mechanically using four screws with flat-washers to prevent marring the front panel.

Rear Support for Road Applications

If the PM-1201 is rack-mounted, and the rack transported, mechanical support for the rear of the amplifier is recommended. This could take the form of a shelf across the rear of the amplifier or brackets that engage the rear of the unit. This practice is recommended for all rack-mounted electronic instruments, especially those that are large, heavy or mechanically deep.

Thermal Considerations

When the PM-1201 is used free-standing, no thermal considerations are necessary. If the PM-1201 is rack mounted, ensure that adequate ventilation exists in front of and behind the amplifier. When several amplifiers are mounted together in a rack, you may need to provide air inlets from the outside of the rack. The PM-1201 brings in cold air from the rear and exhausts it through the front.

PM-1201s may be stacked directly on top of each other without spacer panels. If the amplifier is used with other amplifiers, ensure that the heat output from the other amplifiers doesn't interfere with the cold air supply of the PM-1201 (or vice versa).

The amplifier's cooling system uses a foam filter that must be cleaned periodically to remove any accumulated dust and dirt. A warm solution of mild soapy water works fine. Be sure that the filter is completely dry before reinstalling it on the amplifier.

AC Power Considerations

Ensure that the PM-1201 is plugged into an outlet capable of supplying the correct voltage specified for your model and enough current to allow full-power operation of all the amplifiers plugged into it.

Magnetic Flux Leakage Considerations

The PM-1201 may be mounted without concern for magnetic flux leakage, within the confines of common sense. For example, it's not a good idea to mount any power amplifier near a microphone input transformer or magnetic storage media.

I/O Wiring

The PM-1201 has two types of input connections: XLR female, and 1/4 inch TRS phone jack. Use the connector that is appropriate to your installation.

In addition, a ground system strap allows the amplifier circuit ground to be isolated from the AC line safety ground (green wire). Isolating the grounds may be necessary in some installations to break a ground loop. This is infinitely preferable to breaking the ground pin off the power cord.

FOR CANADIAN MODELS: The difference in ground potential is always limited to less than 4 volts regardless of external connections.

XLR Connector Polarity (Pin 2 vs. Pin 3)

The PM-1201 XLR connectors may be wired for either Pin 2 or Pin 3 hot. The XLR's are supplied from the factory with Pin 3 hot (+). However, the PM-1201 may be internally re-wired for Pin 2 hot (+) by moving two jumpers located behind the XLR connectors on the Input Board. Since this requires careful soldering skills, please refer this modification to a qualified Carver technician.

NOTE: The polarity of the XLR connector does not affect the polarity of the TRS phone jack. The hot pin of the XLR corresponds to the tip connection on the TRS phone jack. The input connectors are connected in parallel; you can parallel the amplifier inputs by patching an unused input connector to its counterpart on the other channel.

Output Connector Wiring

For 2-channel operation, use the red and black binding posts associated with each channel.

For bridged mono operation, use both red binding posts. The left-channel red post is the 'hot' side (noninverting) and the right-channel red post is the 'low' side (inverting).

In either case, ensure that the total load impedance is no lower than that listed in the specifications for the mode of operation that you have selected.

Ground Lift Strap

The ground lift strap is located on the rear chassis of the amplifier near the speaker output binding posts. To break the link between the amplifier's circuit ground and the chassis ground, remove the jumper linking the two terminals. In most cases, the PM-1201 operates best (lowest noise) with the linking installed.

CANADIAN MODELS: An internal auto-isolator circuit limits the potential difference between ground terminals to less than 4 volts regardless of external circuit connections. This is done to conform with Canadian safety regulations.

Warning: For safety reasons, do not separate the ground systems unless absolutely necessary.

Bridging Operation

The PM-1201 has a switch on the rear panel to control bridging operation. For stereo operation, use the INPUT connectors and OUTPUT connectors associated with each channel. The bridging switch should be in the OUT position.

For bridged mono operation, use both the LEFT and RIGHT INPUT connectors, and both red OUTPUT connections. Connect the two amplifier inputs in parallel by patching the unused input jack to its counterpart on the other channel. Depress the bridging switch using a small screwdriver or other tool. The LEFT output is the signal (non-inverting) connection, the RIGHT output is the common (inverting) connection.

Note: Be sure to set both of the input level controls to the exact same setting for equal power distribution per channel.

PM-1201

Note: In bridged mono operation, the output connections are actually a balanced output configuration. This means that neither output terminal may be grounded (both are 'hot').

Caution: We do not recommend using phone plugs for speaker connections, especially with a bridged-mono amplifier. If you must use phone plugs for speaker cables, beware! When connected to a bridged-mono amplifier, the shell of the plug is 'hot' and could cause a nasty surprise if it comes in contact with something or someone that is grounded. At a minimum, insulate the shell of the plug with shrink sleeving.

WARNING: At clipping, the PM-1201's peak output voltage at EACH of the output terminals approaches 125 volts (250 volts peak across both terminals). Therefore, these voltage and current levels should be accorded the same degree of respect as a wall outlet (it CAN be lethal). Class 1 (National Electrical Code) wiring must be used.

Clipping Eliminator

The CLIPPING ELIMINATOR switch turns on the anti-clipping feature of the PM-1201. When the switch is pressed, input signals that are large enough to drive the amplifier output past clipping are reduced to keep the amplifier from clipping. The clipping eliminator circuit keeps the amplifier output below three percent THD at up to 6dB of overdrive.

Note: If the input LEVEL control(s) are turned down far enough, a sufficiently large input signal can drive the input differential amplifier into clipping. Another possibility is that the mixer, equalizer, etc. driving the amplifier may not have sufficient output to overcome the loss introduced by the setting of the input LEVEL control(s). The CLIPPING ELIMINATOR switch has no effect on these causes of clipping.

Power Sequencer

The Sequencer allows remote turn-on and turn-off of any number of PM-1201 amplifiers (or other Carver amplifiers equipped with sequencing capability). In multiple amplifier applica-

tions, the power-on for each amplifier is delayed by 10 to 15 seconds. This allows powering up an entire rack of amplifiers without the turn-on surge actuating the circuit breaker.

Connect the SEND terminal to the RECEIVE terminal of another Carver amplifier. Connect that amplifier's SEND terminal to the RECEIVE terminal of the next amplifier in line, and so on. The last amplifier in line has nothing connected to its SEND terminal. If the ground lift strap is installed, then a common power supply ground connection will be made through the common chassis connection. Otherwise, it may be necessary to install a common ground wire between the signal ground terminals of the amplifiers being sequenced.

Sequencing ON - Set the SEQUENCER switches of the amplifier to ON. Set the MAIN power switches of the amplifiers to OFF. The amplifiers are now ready to be sequenced on in one of three ways.

1. The first amplifier may be switched on remotely via an external DC voltage of +5V to +15V (a common 9V battery will work); OR
2. The first amplifier may be switched on manually with its main power switch; OR
3. The first amplifier has its power switch in the ON position and all the amplifiers AC power is controlled remotely with an AC mains switch.

If method 2 or 3 is chosen, then the system could be sequenced down unintentionally in the unlikely event that the first amplifier should fail or blow a fuse. By switching on the MAIN power switches of the FIRST and SECOND amplifiers, it is possible to assure that the amplifiers will not prematurely sequence off. If method 1 is chosen, then the amplifiers will always remain operating if the first or any other amplifier should fail, because the control voltage will "carry through" from the RECEIVE terminal to the SEND terminal. Therefore, even though the units may be sequenced on with a voltage as low as +5V, it is advisable to apply a voltage within +9V to +15V to assure this voltage will "carry through" the first amplifier should it fail.

Sequencing OFF - The units will sequence off if the first amplifier has its remote DC voltage switched off (method 1) or its power switch manually turned off (method 2 or 3). The units will sequence off at a slower rate that they se-

quence on, which is a function of the power supply decay. If the AC mains are switched off, the amplifiers will not sequence off, but will all turn off simultaneously.

Since the amplifiers are turned off by the absence of a control voltage at the RECEIVE terminal, it is imperative that good connections are made at the SEND and RECEIVE terminals. An open or intermittent connection will cause the amplifiers after the bad connection to power down. It is advisable to use forked tongue or ring type crimp terminals.

Using the PM-1201

Once the amplifier has been installed and wired into your system, you are ready to use it. Here are some tips to help you get the most from it.

- Check the switch settings on the rear panel. Be sure that the bridging switch conforms to the actual mode that you want.
- If you are not using the sequencer, ensure that the SEQUENCER switch is set to OFF.
- Use the clipping-eliminator feature. It works. It saves loudspeakers.
- Be sure that the input LEVEL controls are set sufficiently high to allow the preceding device to drive the amplifier to full output. For most installations, this is wide open.
- When you power the system up for the first time (out of the cartons), it's a good idea to start with all of the amplifier level controls turned down, then advance them slowly, one at a time, so that you can confirm that each amplifier channel is operating normally.
- Once you have established settings, it is a good idea to mark them down, either on paper, or on pieces of tape or sticky-dots attached to the amplifier's front panel.
- In bi-amplified (multi-amp) systems, it is a good idea to start with the low-frequency amplifiers turned off or down, and to check each frequency range from highest to lowest to ensure that each loudspeaker component is operating correctly.

Using the PM-1201 to drive 70V Distribution Systems

The PM-1201 has sufficient output voltage capability in stereo mode to drive 70-volt distribution systems without using a step-up transformer at the amplifier. In this configuration, the PM-1201 delivers 300 watts per channel to the 70-volt system. As with all 70-volt systems, transformers are still required at each loudspeaker.

A 300-watt, 70-volt distribution system has an intrinsic impedance of about 16 ohms. Since the PM-1201 can drive lower impedance loads, additional power is available if we lower the nominal distribution line voltage to the maximum that the PM-1201 can deliver into a stated load impedance. The price for doing this is having to calculate the new transformer tap values at the new line voltage.

The PM-1201 can deliver 450 watts into an 8-ohm impedance (60V line voltage) and 600 watts into a 4 ohm impedance (49V line voltage). Since watts are proportional to the square of the voltage, compute the correction factor by taking the ratio of the square of the line voltages. Then multiply each tap value by this correction factor.

For example, a transformer has taps at 10W, 5W, and 2.5W when used in a 70.7 volt distribution. Its new tap values when used with a PM-1201 and an 8-ohm minimum amplifier load are computed as follows:

1. Compute correction factor K:

$$K = 60^2 / 70.7^2$$

$$K = .7202$$

2. Apply to tap value:

$$\text{marked power} * K = \text{new power}$$

$$10W * .7202 = 7.202W$$

$$5W * .7202 = 3.6011W$$

$$2.5W * .7202 = 1.805W$$

When used in a 60V distribution system, this transformer's tap values are 7.2W, 3.6W and 1.8W. Note that the 3 dB power relationship between each tap still holds true. Similarly, maximum amplifier loading occurs when the sum of the NEW tap values equals the amplifier's output power.

5. Technical Information

Theory of Operation

This section discusses the theory of operation of the PM-1201. Refer to the schematic diagrams presented in Section 6. Opamps used in the circuitry use the following notation: U1(7). This means op-amp U1, whose output appears on Pin 7. Unless otherwise noted, this discussion centers around the left-channel circuitry. The right-channel circuitry is essentially identical.

Low Level Circuitry

Input signals enter the circuit via the rear-panel XLR connector or TRS phone jack. The right channel input circuit includes a phase-reverse switch that is used for mono-bridge operation. U1(1) is configured as a differential amplifier with a gain of 1.47 driving the left-channel level control. On the amplifier board, R1, R2, and U2 form an attenuator whose loss is dependent on the resistance of U2, a LED-LDR module. The drive for the LED portion of U2 comes from the clipping eliminator circuitry, which will be discussed later.

The PM-1201 may be configured to operate as a conventional 2-channel, dual-mono amplifier or a single-channel, mono amplifier with high-voltage output. The operational mode is determined by mono-bridge switch SW1 on the Input Board. For now, assume that SW1 is set for 2-channel dual-mono (stereo) operation.

Power Amplifier Circuitry

The PM-1201 uses the patented Carver Magnetic Field power amplifier circuitry. This innovative circuit uses the combination of a smart power supply and a highly linear, triple-rail power amplifier circuit.

U1(1) is the input stage, providing differential inputs for input and feedback connections as well as most of the open-loop voltage gain of the circuit. The output of U1(1) drives Q14 and Q15 operating as common emitter amplifiers which level-shift the drive signal, provide voltage amplification, and couple it to common-emitter

amplifiers Q13 and Q20. Q14, Q15, Q13 and Q20 provide additional voltage gain which, when combined with the voltage gain of the input op-amp, is sufficient to swing the input signal between the +124 and -124 volt power supply rails. Q16 and Q17 are connected as a NPN-PNP conjugate pair and used as a V_{BE} multiplier for bias control. Q16 is thermally connected to the output transistors and, together with Q17, provides bias stabilization over a wide temperature range. Overall negative feedback from the output stage via R59 sets the closed-loop gain at 30 (29.5 dB).

Up to now, the amplifier circuitry described has been fairly conventional. From this point on, there is a marked departure from convention. The PM-1201 uses a triple-stacked output stage, with each stage having access to its own power supply. Each level of the output stage turns on only when needed, which keeps the power dissipation of the output stage at a minimum.

Ignore the negative-going portion of the output stage for now. The positive-going portion of the output stage is comprised of an emitter-follower drive (Q8) and a series-connected output stage (Q7, Q6/Q24/Q27). The negative-going portion of the output stage is exactly complementary to the positive-going portion, an emitter-follower PNP driver (Q3) and a series-connected output stage (Q4, Q5/Q25/Q30).

The innermost set - that is, the output transistors whose emitters are closest to the output (load) terminals (Q6/Q24/Q27, Q5/Q25/Q30) - is driven from the opposite sides of the V_{BE} multiplier (Q16/Q17). The circuit looks suspiciously like a full-complementary amplifier and is exactly that. Diodes D15-D17 and D31 level-shift the drive signal to the requirements of the innermost output transistors while Q23 is a local V_{BE} multiplier to limit the maximum voltage difference between the output transistor bases.

Q18 operates as a VI limiter, sensing the voltage drop across emitter resistor R110 and reducing the drive signal to the output stage under overload conditions. Q19 operates in similar fashion for the negative-portion of the output stage. Q26 senses current limiting in the negative half of the output stage and passes this signal to the power supply as a shutdown signal. C30 causes Q26 to also turn on in the presence of large high-frequency signals.

Q7, the middle output transistor, receives its drive via D14. When the drive signal exceeds 36V plus 2 diode drops, Q7 begins to turn on and supplies additional voltage output capability via the intermediate 76V power supply. When this occurs, D13 disconnects the 36V supply from the amplifier. The same is true for the negative half of the amplifier (Q4, D25, D24). We now have an amplifier capable of swinging the load from approximately +76V to -76V (minus saturation drops, of course).

Now consider the outermost sets of output transistors (Q9/Q10/Q29 and Q1/Q2/Q28). These transistors are driven (via Q12/Q11 and Q21/Q22) from the positive and negative sides of the driver transistors (Q8, Q3) via zener diodes D34 and D35, which level shift the output signal by the zener voltage towards the 124V power supply rail. As long as the peak AC output voltage remains below the zener voltage, Q12 and Q21 do not conduct. Once the AC output signal exceeds the zener voltage, the outermost output transistors begin to conduct. Diodes D12 and D23 are commutator diodes that disconnect the output stage from the 76V power supply whenever the voltage at the connection point between Q10 and Q7 exceeds 76V. Under high-frequency conditions, C10 and C20 provide phase lead for the outermost output transistors, ensuring that they can “stay ahead” of the audio signal.

Under small-signal conditions, the innermost set of transistors does all the work. As the signal level grows larger and larger, the middle pair of transistors assumes part of the burden. At the highest signal levels, the outermost set of transistors assumes the balance of the burden by providing a high-voltage output signal to the load. This three-stage approach minimizes the voltage across each of the output devices which also minimizes the power dissipation required. Without this approach, the output transistors would be required to support the entire power supply voltage under small signal conditions and the “unused” portion of the power supply voltage would be turned into heat.

Anti-Clipping Circuit

The PM-1201's input operational amplifier, U1(1), also drives a bridge rectifier (D1 through D4). The output of the rectifier drives the LED portion of U2, an LED/LDR module. U1(1) is

inside the overall feedback loop, thus the signal voltage at this point is quite low unless the feedback loop loses control (such as at clipping). Under these conditions, the output of the bridge rectifier is sufficient to illuminate the LED in U2, which reduces the resistance of the LDR portion of U2 which, in turn, reduces the drive signal to the amplifier. The net result is a moderately fast limiter that is activated by amplifier clipping.

Magnetic Field Power Supply

The main power supply for the PM-1201 incorporates a triple voltage design which provides no-load voltages of plus and minus 124, 76, and 36 volts DC. Triac Q5 drives the primary of the magnetic-field power transformer. Q5 operates as a phase controlled switch; its gate signal is ultimately determined by the DC control current flowing through the LED from the AC power line. Diode bridge D1 through D4 provides steering for the phototransistor in U2, allowing the triac to be controlled on both alternations of the power line. The phototransistor, resistors R6-R7, capacitor C6, and transistors Q1-Q4 make up a phase-shift firing circuit that triggers the triac earlier or later in the AC cycle depending on the phototransistor's conduction. R10-R11 function during initial turn-on and cause the power supply to operate at a low level. This level is sufficient to make the amplifier's internal regulation circuitry begin to function. The regulator then takes over and brings the level of power supply activity to the point required for normal operation.

Op-amp U1(1) drives the LED portion of the main opto-isolator U2. U1(1) operates as a differential amplifier whose inputs are each of the positive and negative power supplies, suitably scaled, plus an additional negative contribution via potentiometer R34. Because of the polarity of the input signals, U1(1) adds the absolute value of its input voltages (after scaling) and inverts them. Thus, if the magnitude of the power supply voltages decrease, U1(1)'s output will become more positive. As a result, the LED in U2 glows more intensely, which causes the triac to be triggered earlier in the AC cycle. The net result is an increase in power supply activity that serves to stabilize the DC output at the proper 124 volt level. Control R34 serves to adjust the quiescent voltage across the main filter capacitors C1 and C2 to exactly 124 volts each.

DC Fault Protection

Op-amp U1(7) on the power supply board is configured as a differential comparator, which is driven from the amplifier outputs by way of a low-pass filter. The comparator's output is normally held low (-15 volts) by R15. If a significant amount of DC should appear at the output of either channel, it will be routed via either D3 or D4 and cause the comparator output to switch high (+15 volts). This positive voltage is coupled via R19 and D5 into the base of Q2, turning it on. This, in turn, causes Q4 to turn on, sending a positive current into the inverting input of differential amplifier U1(1). The current is inverted and causes U1(1)'s output to drop near zero. This action deprives opto-isolator U2 of drive, turning off the triac and effectively shutting down the power supply.

Short Circuit/Low Impedance Load Protection

Q1 on the power supply board monitors the activity of the current limit sensing transistors (Q26) in each amplifier channel. If the protection transistors are triggered (by a low impedance load, output terminals shorted, or high frequency overload), Q1 switches on and its collector pulls positive. This action turns on Q2 which shuts down the power supply as described above. C4 and C15 allow a momentary delay to avoid nuisance tripping on momentary overloads.

Display Circuit

The clipping indicators are driven by transistors Q10 (left) and Q12 (right) located on the power supply PCB. Each transistor drives one of the LEDs. The signal for the clipping indicators comes from the main amplifier boards from U1(7) via voltage divider R97/R12. This is the same signal that operates the anti-clipping opto-isolator.

The display driver circuit comprised of U1 (4,3,12,10) and U2(12,3,4,10) is basically a ladder comparator driving LEDs with a twist. Assume that the signal at U1 Pin 2 is zero volts and ignore R23 and D4 for now. R12 and R13 comprise a voltage divider that establishes a reference voltage for the comparators (four per channel). The comparators compare their input signal against the voltages established by the tapped voltage divider made up of R21, R19, R17 and R24. The left channel LEDs are in the following sequence (lowest to highest): D1 (green), D10 (red), D9 (red), D8 (red), D7 (red), D6 (red), D5 (yellow).

The display board receives audio via J1, which is rectified by D22 and filtered by C2. With the input signal at zero volts, all of the comparator outputs are at -12 volts. None of the LEDs (except D11 and D18 power ON indicators) have any voltage across them; all are extinguished. U1(4)'s output is high; all of the other comparator's outputs are low. As the input signal rises, it crosses, in sequence, the thresholds established at each of the four comparators. First, U1(3) fires; its output goes high, and D10 illuminates. Next, U1(12) fires, its output goes high; D10 extinguishes (no net voltage across it) and D9 illuminates. Finally, U1(10) fires; D9 extinguishes, and (this is the twist) D4/R23 supply current to the bottom of the R17, R19, and R21 voltage divider, which inverts the relationship of the comparators to each other.

When U1(10) fires, the current through R23 reverses the sequence of the voltages that establish the thresholds for the three comparators. This allows the same comparators to perform double-duty. The new thresholds leave U1(10) high, U1(4) low, U1(12) and U1(3) low and D8 on. D6 and D7 are off. As the input signal rises further, U1(12) fires, extinguishing D8 and illuminating D7. Next, U1(3) fires, extinguishing D7 and illuminating D6. Finally U1(4) fires, extinguishing D6. The last LED is the clipping/protection indicator, D5.

6. Schematic Diagrams

CAUTION

These servicing instructions are for use by qualified personnel only. To avoid electric shock do not perform any servicing other than that contained in the Operating Instructions unless you are qualified to do so. Refer all servicing to qualified service personnel.

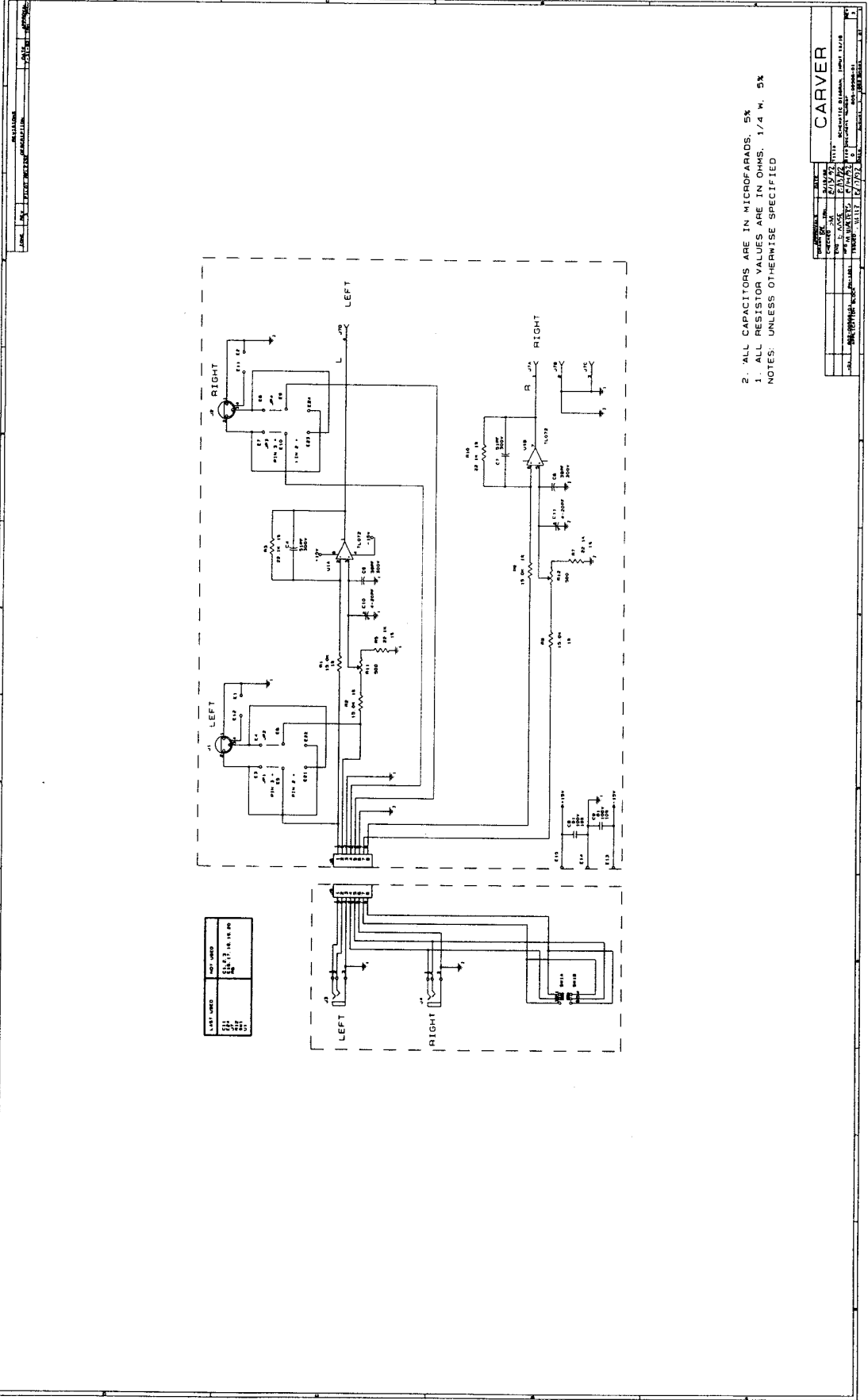

2. ALL CAPACITORS ARE IN MICROFARADS, 5%
 1. ALL RESISTOR VALUES ARE IN OHMS, 1/4 W, 5%
 NOTES: UNLESS OTHERWISE SPECIFIED

DESIGNED BY	DATE	REVISION
CHECKED BY	DATE	REVISION
APPROVED BY	DATE	REVISION
CARVER		
CARVER ELECTRONIC CORPORATION 1000 W. 17th St., Santa Ana, California 92705 TEL. (714) 241-1111 FAX (714) 241-1112 CIRCLE 127 ON READER SERVICE CARD		

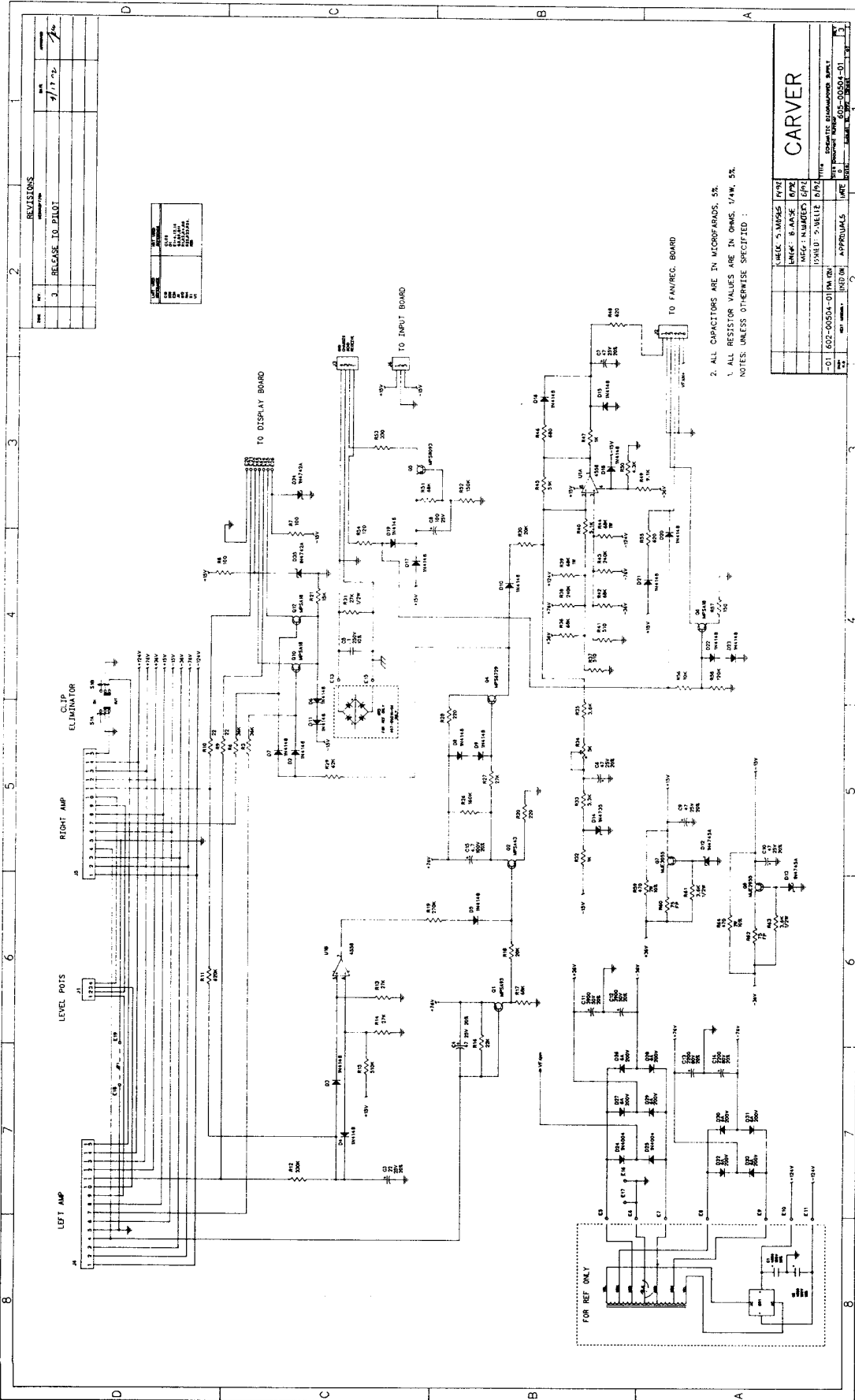

REVISIONS

NO.	DATE	DESCRIPTION
1	7/17/72	RELEASE TO PILOT

DATE	7/17/72
BY	...
CHECKED	...
APPROVED	...

CHECK 5-VALUES	19/72
BRIDGE 8-VALUE	19/72
10K/10 5-VALUE	19/72
APPROVALS	DATE
IND. ON	

CARVER

PROJECT: PM-1201-01
 DRAWING NO: 605-00501-01
 SHEET NO: 18

2. ALL CAPACITORS ARE IN MICROFARADS, 5%.
 1. ALL RESISTOR VALUES ARE IN OHMS, 1/4W, 5%.
 NOTES: UNLESS OTHERWISE SPECIFIED:

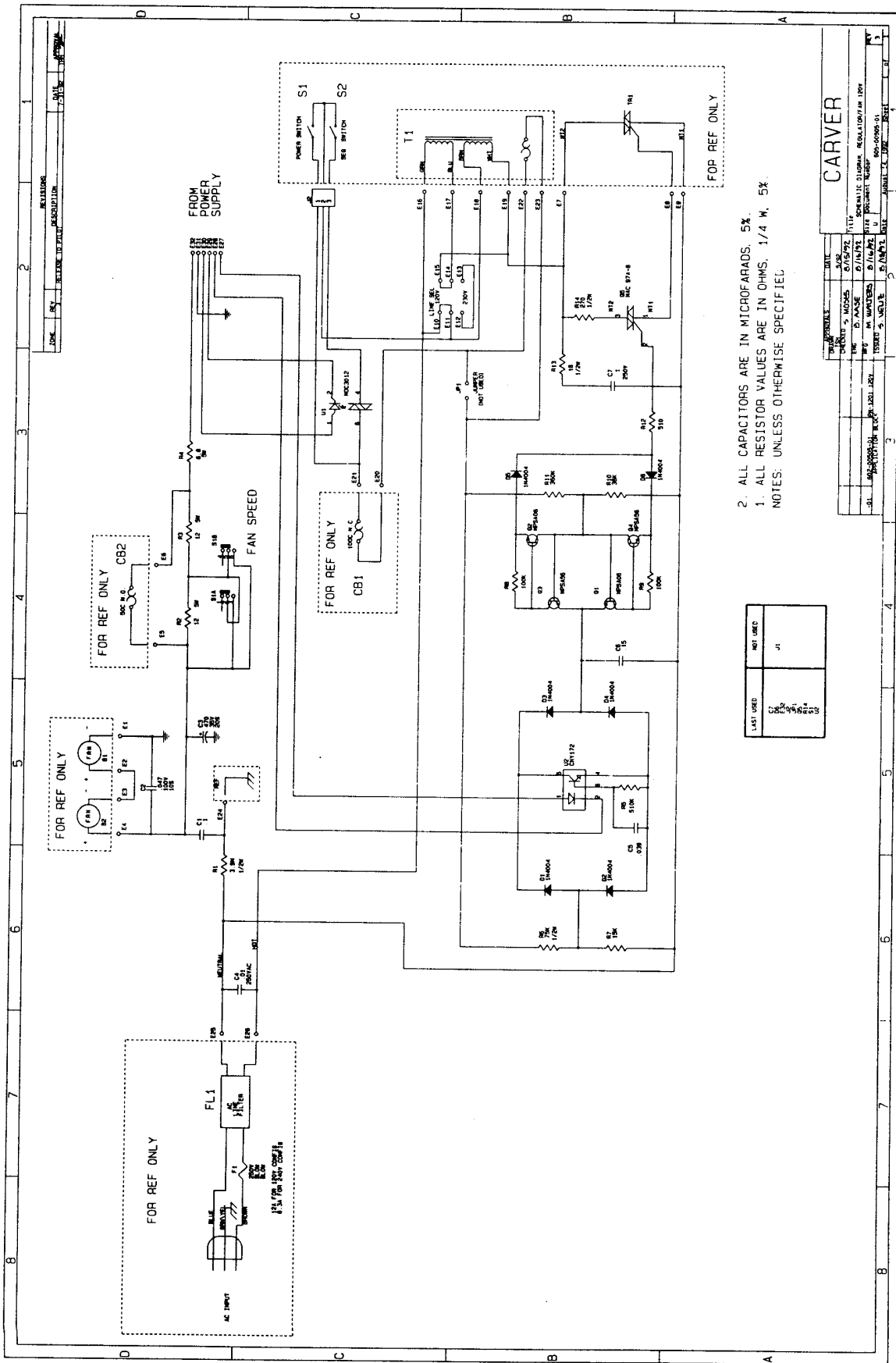

- 2. ALL CAPACITORS ARE IN MICROFARADS, 5%.
 - 1. ALL RESISTOR VALUES ARE IN OHMS, 1/4 W, 5%.
- NOTES: UNLESS OTHERWISE SPECIFIED.

LAST USED	NOT USED
11	

REVISIONS		DATE	BY
1	INITIALS	0/15/72	TJH
2	DATE'S	0/15/72	TJH
3	NO. OF SHEETS	11	
4	TITLE	SCHEMATIC DIAGRAM REGULATORY PM 1201	
5	PROJECT NO.	600-0000-01	
6	DESIGNER	U	
7	CHECKED	U	
8	APPROVED	U	
9	DATE	08-15-72	
10	SCALE	1:1	
11	FILE NO.	600-0000-01	

CARVER

ZONE	REV	DESCRIPTION	DATE	APPROVED
0	PROTOTYPE		7-19-79	JAC
1	RELEASED TO PILOT (PM 600)		9-20-79	JAC
2	RELEASED TO PILOT (PM 900)		12-4-80	JAC
A	RELEASE TO PRODUCTION		1-7-90	JAC

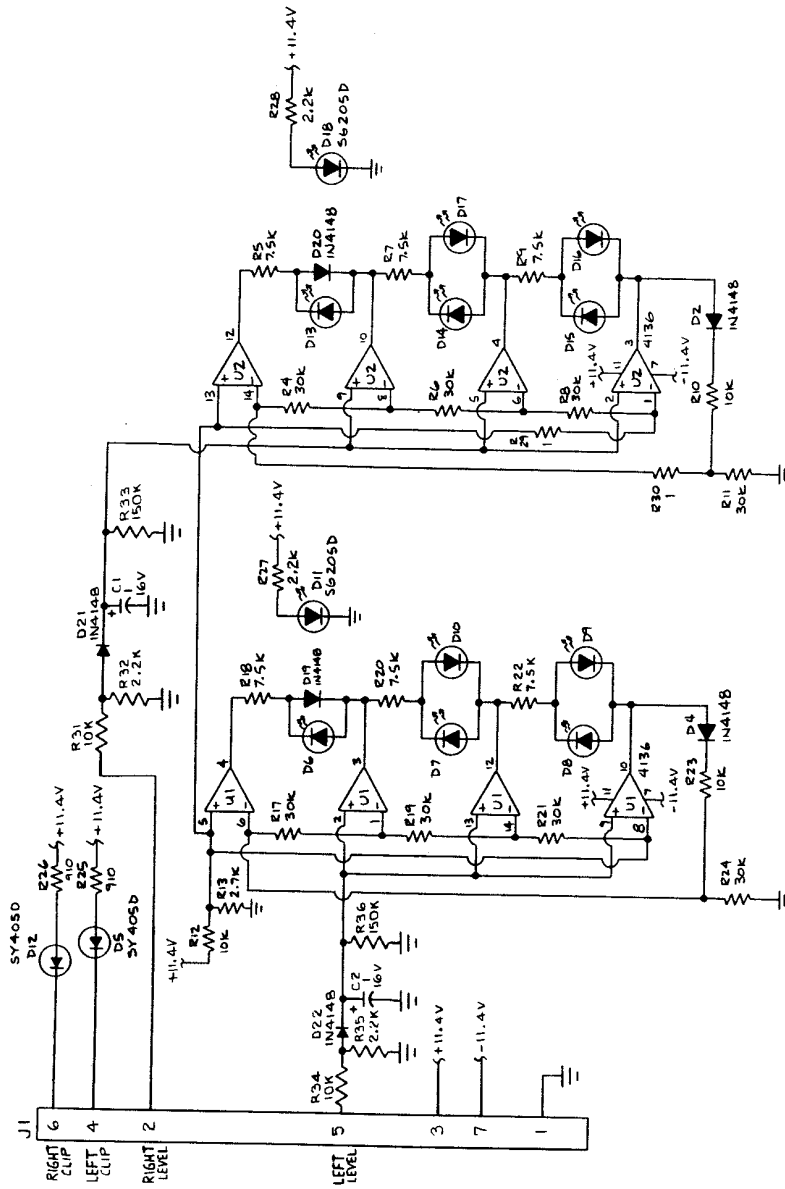

- NOTES: UNLESS OTHERWISE SPECIFIED.
1. ALL RESISTORS ARE IN OHMS, 1/4 W.
 2. ALL DIODES ARE SR 505 W.
 3. ALL CAPACITORS ARE IN MICROFARADS, 5%.
 4. REF DESIGNATORS LAST USED: C2, D22, R36, U2.
- NOT USED: D1, 3, R1, 2, 3, 14, 15, 16.

CONTRACT NO		APPROVALS		DATE	
UNLESS OTHERWISE SPECIFIED TOLERANCES ARE FRACTIONS DECIMALS ANGLES		DRAWN		DATE	
MATERIAL		CHECKED		DATE	
FINISH		ISSUED		DATE	
DO NOT SCALE DRAWING		FIG		DATE	
NEXT ASSEMBLY USED ON		SCALE		SHEET	
APPLICATION		DWG NO		REV	
		PM 600/900		605-00410-00	
		1		A	

CARVER
SCHEMATIC DISPLAY

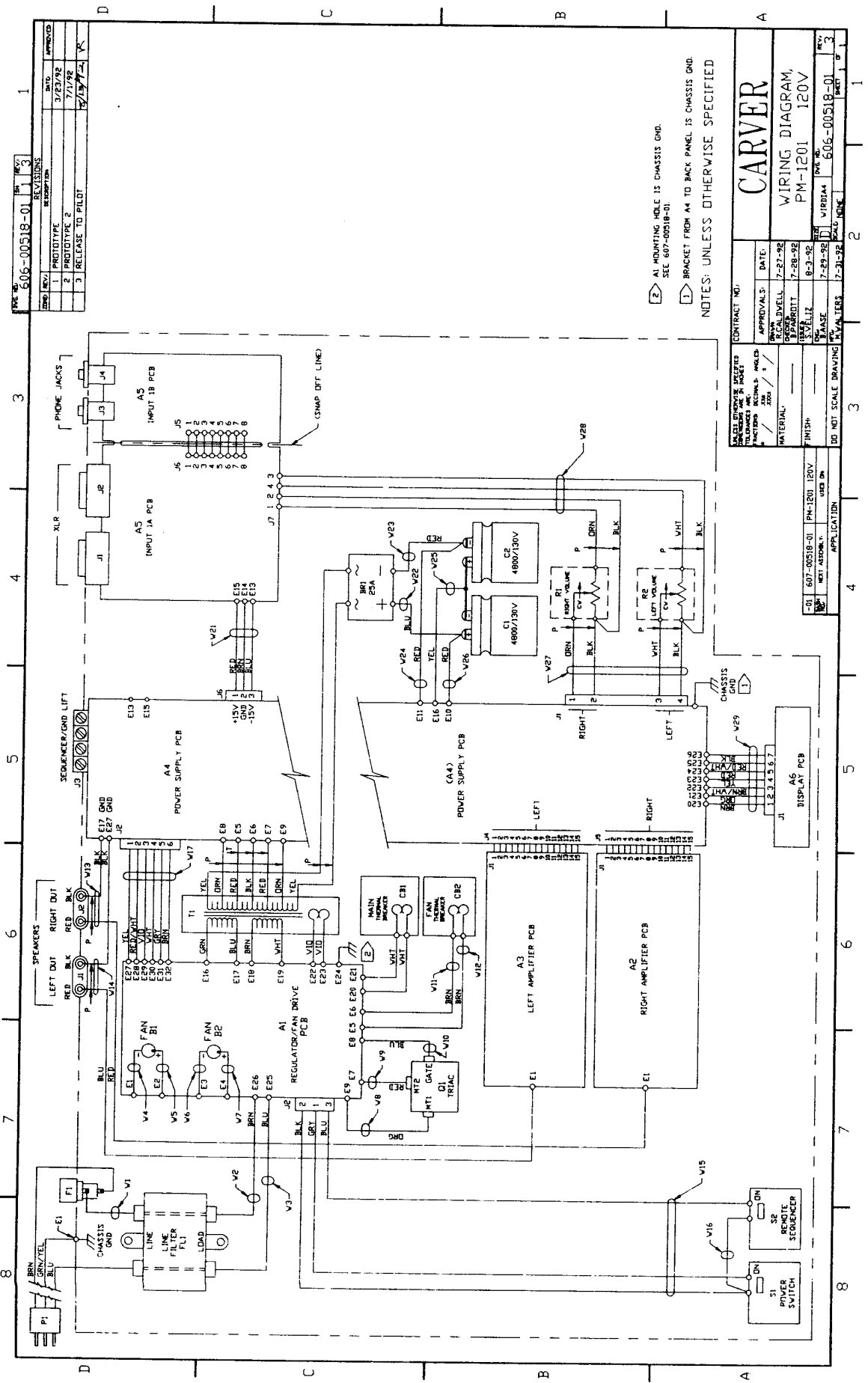

REV.	DATE	DESCRIPTION
1	3/23/92	PROTOTYPE
2	7/1/92	PROTOTYPE 2
3	7/1/92	RELEASE TO PILOT

NOTES: UNLESS OTHERWISE SPECIFIED
 A1 MOUNTING HOLE IS CHASSIS GND.
 SEC 607-00518-01
 BRACKET FROM A4 TO BACK PANEL IS CHASSIS GND.

CONTRACT NO.		DATE	
APPROVALS:		7-27-92	
RECALDWELL		7-28-92	
VIRBILIZ		8-3-92	
BASE		7-29-92	
VALIERS		7-31-92	

MATERIAL		FINISH	
DO NOT SCALE DRAWING		APPLICATION	
PART 1 OF 1		USED ON	
PART 2 OF 1		USED ON	
PART 3 OF 1		USED ON	
PART 4 OF 1		USED ON	
PART 5 OF 1		USED ON	
PART 6 OF 1		USED ON	
PART 7 OF 1		USED ON	
PART 8 OF 1		USED ON	
PART 9 OF 1		USED ON	
PART 10 OF 1		USED ON	

PART 1 OF 1		USED ON	
PART 2 OF 1		USED ON	
PART 3 OF 1		USED ON	
PART 4 OF 1		USED ON	
PART 5 OF 1		USED ON	
PART 6 OF 1		USED ON	
PART 7 OF 1		USED ON	
PART 8 OF 1		USED ON	
PART 9 OF 1		USED ON	
PART 10 OF 1		USED ON	

7. In Case of Difficulty

If the PM-1201 should fail to operate, here is a checklist of things to check before contacting an Authorized Carver Service Center (or the factory).

No Lights, No Sound

No lights, no sound is usually a power supply problem (either the power line itself or the amplifier's power supply).

- Is the amplifier plugged in?
- Is the outlet live?
- Is the fuse okay?
- Is the power switch set to ON?
- Has the amplifier overheated?

Low Output or No Output

Low or no output problems are usually signal-source, bad cable, or partial-output short circuit related. If the items listed below check out, then the problem may be internal to the PM-1201.

- Check the input LEVEL controls and set them to their normal settings.
- Move the input connections to another amplifier that you know is working to verify that it is not a source problem.

- Check the speaker connections. Be sure that there are no small strands of wire touching similar strands coming from the other wire in the cable. If you use banana plugs, be sure that the setscrews in the plug are securely tightened.
- Make sure the speakers are functioning correctly.
- If you are using bridged-mono mode, ensure that the bridged-mono switch is depressed.
- Use a voltmeter to determine if the power line voltage is dropping excessively when the amplifier is driven hard.

Distortion

Distortion is usually caused by excessive loss in the input controls (the mixer/equalizer/crossover can't produce enough output), overdriving resulting in output clipping, or current limiting caused by excessively low load impedances.

- Check the setting of the input level controls. If set too low, the preceding piece of equipment may not have sufficient output to overcome the loss. This is especially possible if you hear distortion but the yellow CLIPPING LED(s) are not illuminated.
- If the yellow CLIPPING LED is illuminated, check the speaker connections. Verify that all setscrews are tight and that there are no stray strands of wire to cause short circuits.
- Verify that the total load impedance presented to the amplifier is within the limits described in this manual for the mode of operation selected.

8. Warranty Information

Note: We suggest you read the LIMITED WARRANTY completely to fully understand your warranty/service coverage. Please promptly complete and return the WARRANTY REGISTRATION CARD. Also be sure to save the sales receipt in a safe place. It will be necessary for warranty service.

If your CARVER product should require service, we suggest you contact the Dealer from whom you purchased your unit. Should the Dealer be unable to take care of your needs, you may contact the CARVER Technical Service Department by phoning (206) 775-6245 or by writing to us at the Factory address shown at the right. We will then direct you to the nearest in our national network of Authorized Warranty Service Centers or give you detailed instructions on how to return the product to us for prompt action.

If you should have questions or comments, please write to the Factory address given below. Please include the model and serial number of your Carver product, your complete address and a daytime phone number.

Factory Address

Carver Corporation Service Department
P.O. Box 1237
Lynnwood, Washington 98046-1237
(206) 775-6245

Carver Corporation reserves the right to improve its products at any time. Therefore, specifications are subject to change without notice.

© 1992 Carver Corporation. All rights reserved.

Pub #920805-A, Part #990-20142-00
Written, designed and printed in U.S.A.

Magnetic Field technology protected under U.S.
Patent 4,218,660

CARVER

P R O F E S S I O N A L